

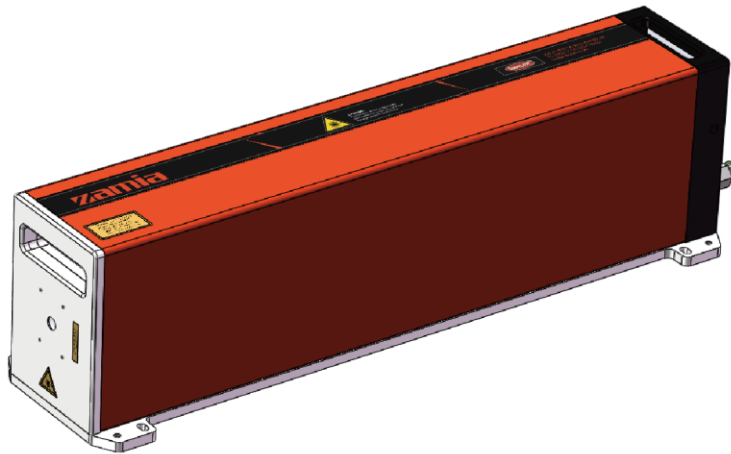

OPERATORS MANUAL

F8 CO₂ RF LASER



CONTENT

Chapter 1 Introduction	1
1.1 Trademark, Copyright, Version, Model.....	1
1.2 Warranty Information.....	1
1.3 Unpacking/ packing, storage/ shipping, mounting, connecting, cooling	2
1.4 Basic Description	2
1.5 Packing list.....	3
Chapter 2 Safety Instructions & Precautions.....	3
2.1 Summary.....	3
2.2 Hazard Labels.....	4
2.3 Operation instructions.....	4
2.4 Safety precautions	5
Chapter 3 Product Introduction	5
3.1 Brief	5
3.2 Applications& Materials.....	5
3.3 Parameters& Operation Requirements	6
3.4 Product Structure	7
Chapter 4 Mounting Instructions	8
4.1 The Outline & Mounting of F8.....	8
4.2 Operation Environment.....	8
4.3 DB15 Connector	9
4.4 DC Cable	10
4.5 Power System	11
4.6 Cooling	12
4.7 Control signals	15



4.8	External Laser Path Protection.....	16
4.9	Fixing.....	17
4.10	Cooling Alert.....	17
Chapter 5 Control & Operation		18
5.1	Operation Preparations.....	18
5.2	Control terminal	18
5.3	Control Signal Interface	19
5.4	Control & Indicators	21
5.5	Start-up and pulse mode	22
5.6	Laser Operation Safety Tips.....	22
Chapter 6 Technical Reference.....		23
6.1	Optical resonator	23
6.2	Cooling	24
6.3	Polarization	24
6.4	Back-reflected beam isolation principle	24
6.5	External optical path & attentions.....	25
6.6	RF Power supply.....	25
6.7	Cooling & coolant temperature setting.....	26
6.8	Modulation signal & PWM method.....	26
6.9	Marking & engraving	27
Chapter 7 Maintenance.....		28
Chapter 8 Q&A.....		29



Chapter 1 Introduction

1.1 Trademark, Copyright, Version, Model

Trademark

ZAMIA® is registered trademark of SPT LASER co., ltd., all the other ZAMIA trademarks are the property of their respective owners.

Copyright

This is the SPTOM-CF8-20.01 version, all rights reserved by SPT LASER. Reprint and copy of this manual, including versions in other languages are forbidden without written authorization from SPT LASER company.

Version

This manual is for operation of F8 series CO₂ RF Laser. Read it carefully before you use and operate F8, and the latest version of this manual will be updated at www.sptlaser.net.

Model

There is only difference on the output power and wavelength between F8 and F8i, other parameters are the same. F8 is mostly used for instruction in the manual. Please refer to this manual for detailed product information.

1.2 Warranty Information

This is to certify that F8 CO₂ laser is guaranteed by SPT Laser co., ltd to be free of all defects in quality for a period of 26 months from the date of purchase. The warranty does not apply to any defect caused by misuse (including environmental factors), accident and improper maintenance. We request that you examine every shipment of 7 days after receipt and inform SPT LASER co., ltd of any storage or damage.

If, within warranty, any defect in materials and workmanship of your F8, please contact SPT LASER co., ltd. When contacting for support, please provide the date of purchase, model, serial number and brief description of the problem. And keep all the labels on the laser complete.

**The situations are not applied to the warranty:**

1. Man-made sabotage
2. Warranty expired
3. No product info label and valid invoice, or the sealed
4. Any damage caused by improper maintenance, mounting, adjustment and misuse
5. Parts removal and repair without authorization of SPT LASER co., ltd.
6. Damage caused by force majeure

Contact Info

Email for support: support@laserwd.com

For more info, please check at www.sptlaser.net

1.3 Unpacking/ packing, storage/ shipping, mounting, connecting, cooling

We request you to keep the original packing of F8, to prevent any damage to the laser in storage and shipping.

For more info, please look up in this manual.

1.4 Basic Description

F8 CO₂ RF laser is used for laser cutting, drilling, marking on non-metallic materials.

F8 requires DC power input, a DC power supply with 48V/25A output is recommended. The cable connecting the DC power supply and the laser should be as short as possible, and copper cables with cores more than 4mm² are required. Please thicken the wire appropriately and be sure to fix it tightly, if the power cord is long.

F8 is cooled with coolant, and the cooling pipe has to be ID7.5mm and OD10mm, each single pipe is required to be less than 4m.

Please use high-purity nitrogen or filtered clean air without water, oil and dust if need to blow air to the laser.

The test report shows the parameters of F8 tested before being packed, it can be found in the carton.



1.5 Packing list

F8 RF CO2 Laser ---1pcs
DB15 male head ----1pcs
Wire copper connector (L type) ----1pcs
DB-15plastic case set ---1pcs
Test report ----1pcs
F-Series Instruction ----1pcs
Packing list ----1pcs

Chapter 2 Safety Instructions & Precautions

2.1 Summary

According to Chinese national standard, GB7247.1-2001(IEC60825-1:1993), this product is class 4 laser. It can cause personnel injury and fire due to its refraction, reflection, diffuse reflection, please always be careful!

Read the entire manual and follow its instruction to make sure the correct operation of laser and personnel safety prior to shipping, mounting, and maintenance. Incorrect operation can cause damage to laser.

Please look up the alerts and hazard labels in this manual.

DANGEROUS This Class 4 laser product emits invisible infrared laser radiation.

Because direct or diffuse laser radiation can inflict severe corneal injuries, always wear eye protection when in the same area as an exposed laser beam. Do not allow the laser beam to contact a person, this product emits invisible laser beam which can burn the human tissues seriously. And any use of laser in explosive environments is banned.

WARNING Poisonous and harmful dust or gas may be generated during laser processing, effective exhaust or ventilation conditions are necessary for operators' safety.

ATTENTION Please go through and follow the guide in the manual on shipping, mounting, operation and maintenance of laser, incorrect operation can do harm to laser.

2.2 Hazard Labels

There are totally 5 hazard labels on F8 CO₂ laser, please check the info as below to know where they are located.

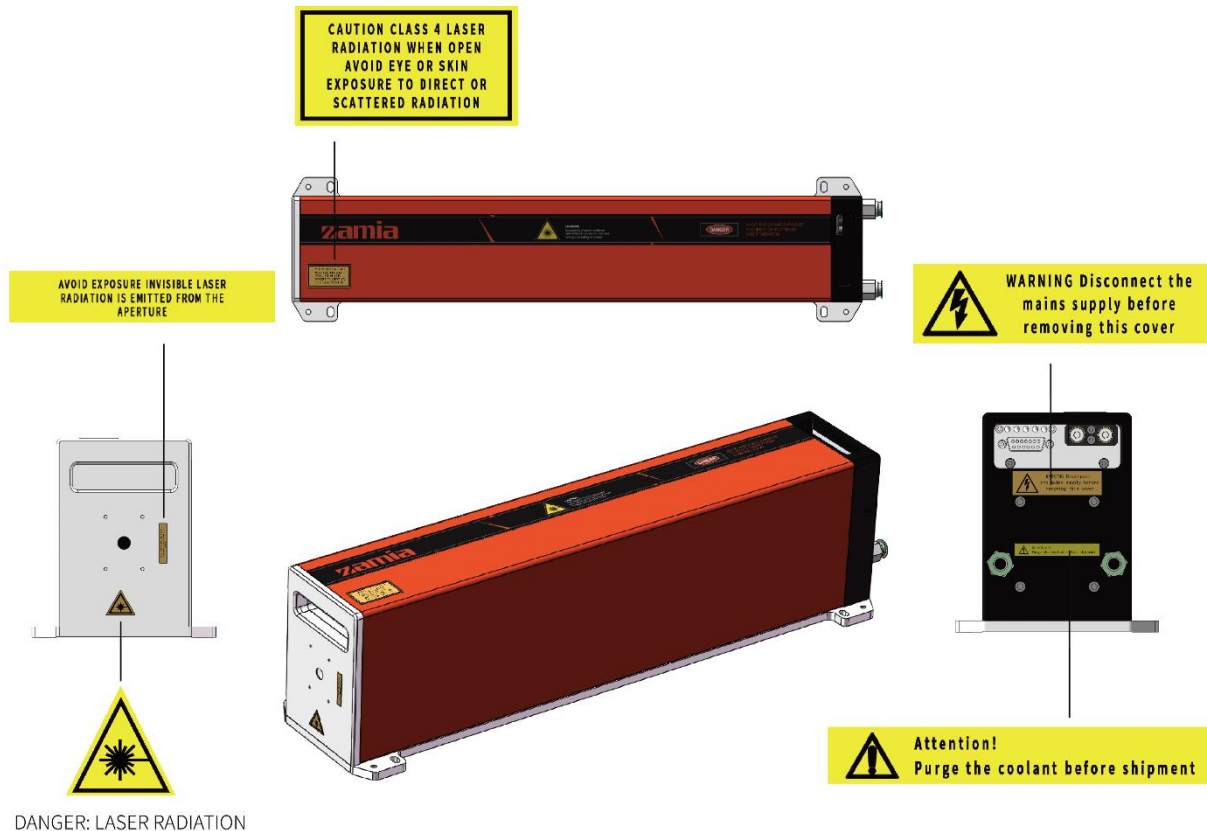

2.3 Operation instructions

1. Always wear eye protection to avoid any damage from laser.
2. Avoid any contact to combustible materials or humans from laser beam, it is capable of seriously burning human tissue.
3. Do not process on any high reflection material, any reflect or diffuse laser radiation can cause damage to devices and personnel.
4. Do not use any organic materials and metals as laser beam blocker. Organic matter burns or melts easily, and metal reflects the laser radiation.
5. Any personal disassemble and modification on laser fails the warranty.



6. Keep the laser working in good ventilation condition. Too much heat in laser can cause damage.

2.4 Safety precautions

Emergency stop

Use under emergency to stop laser by cutting the power.

Set up warning signs and control areas

Set up warning signs and blockers in the same area as an exposed laser beam.

Fire extinguisher

CO₂ or dry powder fire extinguisher shall be kept nearby where the laser is installed.

Chapter 3 Product Introduction

3.1 Brief

Output with circularly symmetric near TEM00 mode Gaussian beam;

- All-metal structure with sealed off design, maintenance free;
- RF power supply and cavity integrated package, appearance simplicity & easy to be integrated;
- Compact structure, high-grade dust-proof design, suitable for a variety of industrial environments.

3.2 Applications& Materials

Applications

F8 CO₂ RF laser is suitable for laser cutting, laser marking, plastic welding, and 3D printing.

Materials

Processing of leather, wood, plastic and other non-metal materials.

Processing of special materials, such as ABS, Teflon, asbestos, rubber, etc.



3.3 Parameters & Operation Requirements

Dimension and weight

Size(L×W×H)	565.6x143 x 154.5mm
Package(L×W×H)	680x300x250mm
Weight	12.9Kg

Technical Parameters

Model	F8	F8i
Wavelength	10.6±0.1 μm	9.3±0.1 μm
Average Power	80W	65W
Maximum Power	80W	65W
Output Power Range	1~80W	1~65W
Beam Quality (M ²)	<1.2	
Modulation Frequency	1KHz ~100KHz	
Power Stability	≤±7%	
Laser Spot Size (1/ e ²)	2.0±0.3mm	
Beam Divergence (Full)	<7.0mrad	
Beam Ellipticity	<1.2	
Polarization	Linearly polarized, Vertical to the base	

3.4 Product Structure

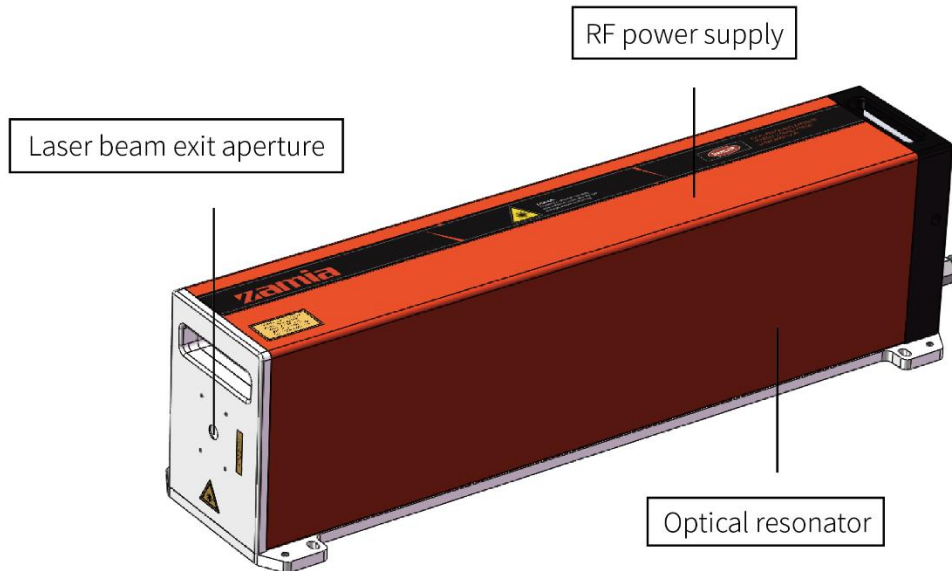

F8 CO₂ RF laser is covered with an all-aluminum case, structure inside are two independent parts, the upside part is the RF power supply and the downside one is the laser optical resonator.

Laser chamber

Laser chamber is a full sealed metal structure with high heat conductivity which ensures good thermal stability of laser. There are discharge electrodes to excite the laser gas in the resonator, and their discharge surfaces are the wave guide surface of optical resonator. The design of laser chamber inside enables the laser to output stable power and perfect laser spot mode.

RF power supply

The RF power supply supplies pulsed RF power to excite and ionize the laser gas in the resonator. The pulse width and period of the laser can be controlled with external modulation signal.



Chapter 4 Mounting Instructions

4.1 The Outline & Mounting of F8

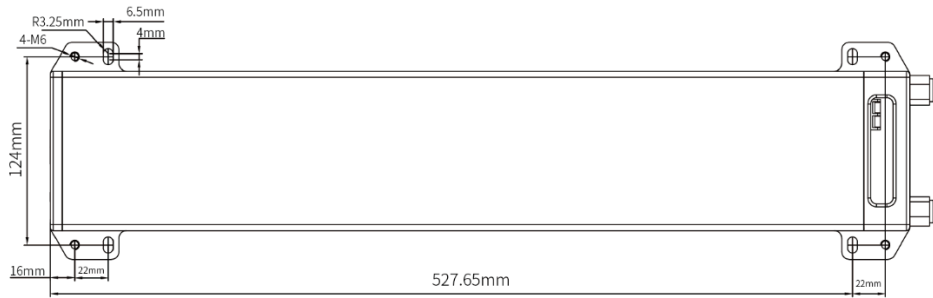

F8 top view

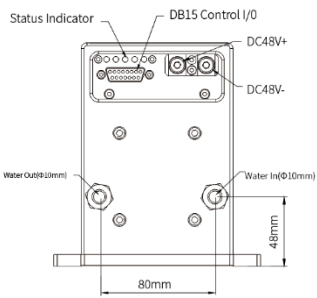

F8 back view



F8 side view

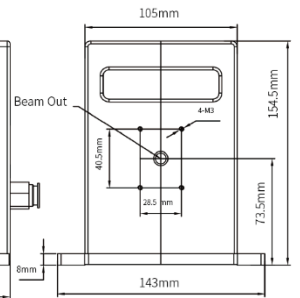

F8 front view

4.2 Operation Environment

Requirements:

Temperature	5~45°C (41~113°F)
Humidity (no condensation)	<95%
Altitude	≤2000m



4.3 DB15 Connector

Please follow the diagram as below to do the wiring when you use F8 CO₂ RF laser for the first time. For more detailed wiring info, please look up from Chapter 5, Section 5.4. Recommend to use ID 7.5mm and OD10mm cooling pipe to connect the water inlet and outlet directly.

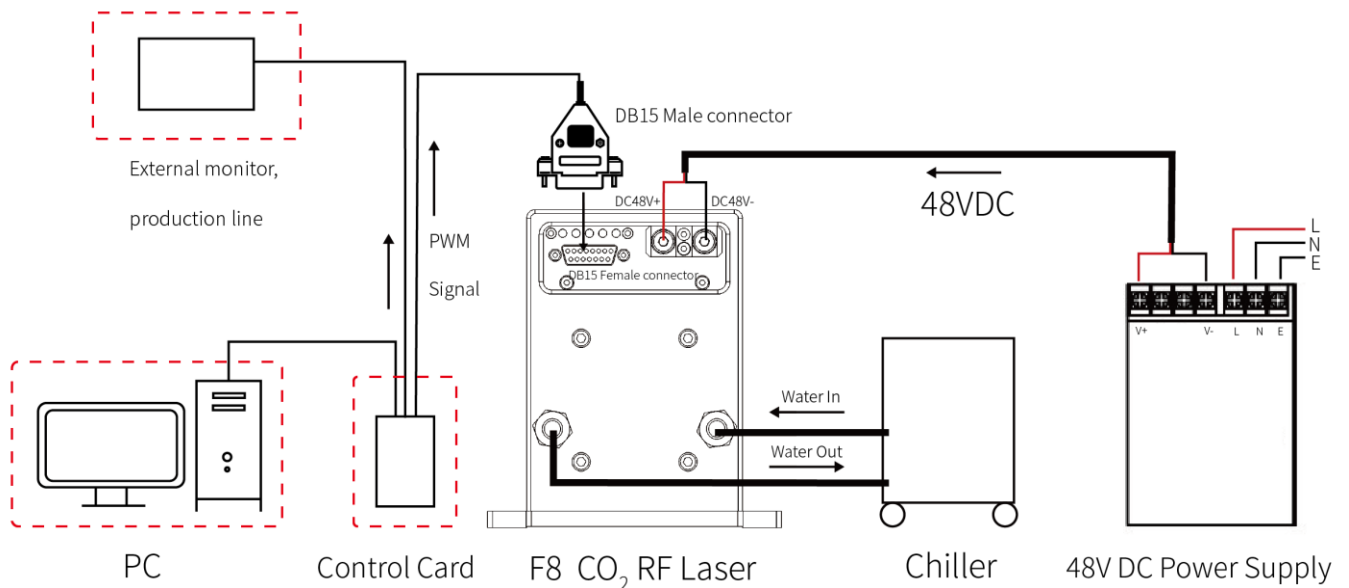
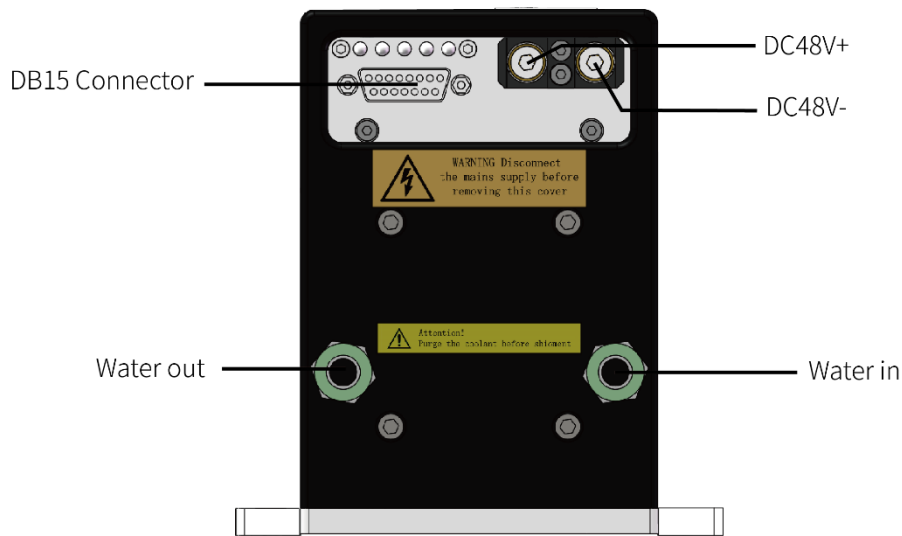

F8 CO₂ laser wiring diagram



4.4 DC Cable

F8 CO₂ laser works with DC power, a DC power supply with 48V/25A output is recommended. The DC cable must be multiple twisted wires with reliable insulation performance, and the thickness of its conductive core shall be $>4 \text{ mm}^2$ and $<6 \text{ mm}^2$. The DC cable shall be no longer than 4m. If the power cord is longer than 4m, thicken the wire appropriately and be sure to fix it firmly, and check the input voltage to laser, make sure it is 48V.

Keep the wiring of the control cable away from the electrical appliances and cables with high voltage, high current and electromagnetic radiation to prevent the laser control signal from being interfered.

The multiple relationship between the current-carrying capacity of the insulated wire and the cross-section.

The unit of the wire is mm^2 , divided into two types: copper core wire and aluminum core wire, copper core wire is generally used.

Common wire section (mm^2):

1、 1.5、 2.5、 4、 6、 10、 16、 25、 35、 50、 70、 95、 120、 150、 185

Load current value of wire specified in GB4706.1-1992/1998

1 mm^2 (6A~8A)..

1.5 mm^2 (8A~ 15A)..

2.5 mm^2 (16A~25A)..

4 mm^2 (25A~32A)..

6 mm^2 (32A~ 40A)..

For a wire of 1.5, 2.5, 4, 6, 10 mm^2 the cross-sectional area can be multiplied by 5.

For a 16, 25 mm^2 can be multiplied by 4.

For a 35, 50 mm^2 can be multiplied by 3.

For a 70, 95 mm^2 can be multiplied by 2.5.

For a 120, 150, 185 mm^2 can be multiplied by 2.



4.5 Power System

Choose external power supply which meets all the requirements to ensure the laser works smoothly. The internal power system of the laser is with high-frequency and high-power, an unqualified external power source can cause damage to the internal power system.

Materials and Tools required

1. DC power supply; 2. Cable; 3. Multimeter; 4. Oscilloscope; 5. DC cable

DC Input of F8

Max.current	25A
Voltage	DC48V±0.5V
Continuous working current	≤25A

Operation precautions

DC power supply must come with good instantaneous current and voltage adjustment capability, peak current required by laser affects the working life of DC power supply directly. When laser stops firing, the current load on DC power supply drops from high value to near 0 suddenly, same time, the voltage output of DC power supply increases in a moment, if the voltage goes up to be more than 53V, it can cause damage to the power transistor in RF amplifier, which will end up to laser power drop or laser damage.

The laser requires high peak current from DC power supply when it fires. In the case of high load current, the voltage output of DC power supply drops, but it shouldn't drop too much. If the voltage is less than 43V, the laser doesn't work normally. The peak voltage of DC power supply shouldn't last more than 10 μ s, and duration of DC power supply peak current should be 1/3 of the laser start pulse width. (E.g. The DC power supply peak current should last more than 100 μ s if the start pulse width of laser is 300 μ s.)

Connect V- (output) on DC power supply to ground. And also connect the cathode on laser to ground if the cable for connecting laser and DC power supply is longer than 3m.

1. An overvoltage protection circuit between DC power supply and RF power supply is required to avoid laser damage due to excessive voltage fluctuations.



2. Connect the power supply according to the labels located at the back side of the laser. "+" is anode on RF power supply, connect to "V+" on DC power supply, and "-" is cathode on RF power supply, connect to "V-" on DC power supply. Maximum length of cable connecting DC power and RF on laser is 4m, and twist the cable into a single strand to reduce the mutual inductance between the terminals.
3. The laser shell and DC power supply must be correctly grounded. The laser can be damaged because of not grounded or excessive noise from incorrect grounding.
4. DC power supply test. Firstly, test the DC power supply with multimeter (to check voltage) and oscilloscope (to check ripple) under no-load conditions, and test (use a multimeter, oscilloscope, and ammeter) it again with a laser load (full laser power output), to ascertain each value (voltage and current) of the power supply output parameters meets the demand of F8.
5. Do not apply too much strength when connecting the cable to electrodes on the laser. Too much strength can do irrecoverable damage to the RF amplifier in the laser.

4.6 Cooling

The photoelectric conversion rate of the laser is 10% only, which means only 10% of the electric power input is converted into laser power output, and the remaining power is basically converted into heat. And the heat has to be taken away, otherwise it will be accumulated and increase internal temperature of the laser which will cause damage to components in the laser in the end.

The heat generated in F8 series CO₂ laser is taken away by external cooling system.

Cooling path

Cooling for F8 CO₂ laser requires coolant, ID7.5mm and OD10mm is required pipe size and single side is no longer than 4m. Stainless steel, copper alloy or opaque plastic pipe is recommended.

Filter is required in the cooling path and some chiller comes with a filter. A filter with 100 μm aperture is recommended to.



Replace the filter element every three months to ensure quality of the cooling water.

Cooling requirements:

Heat Load	>1kW
Water flow at the water out on the laser (minimum)	5L/min
Coolant temperature	18°C-30°C (64.4-86°F)
Coolant Temperature stability	±1°C (33.8°F)
Coolant	Anti-corrosion water
Water pressure	105KPa (@5L/min)
Max.static water pressure	827KPa

Pay attention to the factors as below while choosing and using chillers :

1. Cooling capacity ≥1KW
2. The pipe used as cooling path shall be as big as possible. If need to transfer the bigger pipe into a smaller one to match the water inlet/outlet of the laser, the smaller pipe shall be as short as possible.

Coolant temperature setting

There are electronic components, RF power units and optics in the laser, all of them are very sensitive to condensation. If there is condensation on the surface of any of them, it can cause components damage, poor laser output (power and laser beam mode), even the laser can be destroyed. To ensure the laser works normally during operation, the coolant temperature needs to be set properly.

Two things have to be considered about when setting coolant temperature:

1. Ambient temperature; 2. Relative Humidity.

If the laser works in an environment with air conditioning, the coolant temperature can be generally set at 25°C, and the final value is up to the temperature and relative humidity in the area where your laser is operated. Generally, recommend to set the coolant



temperature close to the ambient temperature (within $\pm 2^{\circ}\text{C}$).

Coolant temperature setting

(Based on Ambient temperature and Max. Relative Humidity) for reference ($^{\circ}\text{C}$)

Ambient temperature($^{\circ}\text{C}$)	Max. Relative Humidity (%)							
	30%	40%	50%	60%	70%	80%	90%	95%
5	20	20	20	20	20	20	20	20
10	20	20	20	20	20	20	20	20
15	20	20	20	20	20	20	20	20
20	20	20	20	20	25	25	25	25
25	25	25	25	25	30	30	30	30
30	30	30	30	30	35	35	35	35
35	35	35	35	35	35	35	35	35
40	35	35	35	35	N/A	N/A	N/A	N/A

1. Values given in the chart as above are for reference only, please match the Ambient temperature and Max. Relative Humidity in the area where your laser is running.
2. N/A: the laser can't be operated in this area due to condensation.

Chart explanation

The first column in the chart is the real ambient temperature and the first row is the Max. relative humidity. Values in the column are the cooling temperatures setting for reference. For example, if the ambient temperature is 26°C and the Max. relative humidity is 80%, then the coolant temperature shall be set at 30°C .

Note: please dry the laser if it needs to be stored, shipped or not being operated for a long time. Water left in the laser can cause damage to it.

Cooling water

Do not add additives that are corrosive or affect the flow rate of the liquid, use demineralized water, deionized water or distilled water as the cooling water is recommended.

Cooling water requirements:

Conductivity	<1000 $\mu\text{S}/\text{cm}$
Hardness	<10 ppm
PH value	5-9



Bacterial level	<1000 cfu/ml
-----------------	--------------

*** The cooling water temperature shall be kept above the dew point to avoid condensation of the cooling water inside the laser.**

4.7 Control signals

The F8 laser operation is controlled with external command signal, and requires working enable signal, working modulation signal and an external safety lock device, which can monitor the output signal of F8 CO₂ laser to know the working status.

Material and tool requirements

TTL Logic Generator	Frequency and duty cycle adjustable
Oscilloscope	Oscilloscope bandwidth is decided according to the modulation frequency required by the operator

Command signals requirements of F8(i)

There is around 50mA current sink at laser control terminal when it is powered on, so the command signal must come with sufficient drive capability to avoid big changes in the TTL control signal level. The high level of the control signal should not differ too much when it is with and without load. E.g., if the high-level control signal is 5V under no-load running, then it is better maintained at 4.5V and above when it is loaded.

Note: There is the initial setting of F8 CO₂ laser which is given by the chip in the laser. The external control board don't need to provide pre-ionization signal to the laser to make the laser gas mixture to be in pre-ionized state. A small pulse signal applied to the laser can make it fire immediately.

- **The command signal pin must be always in a controllable state.**

When the signal cable is connected to the F8 laser, the signal of each pin on the connector must be in a controllable state at all times. If the pins are in the high-impedance floating state that uncontrollable level signals can occur.

- **Command signal -- TTL logic**
- **The duty cycle of the modulation signal must be selected according to different lasers. The high-level pulse width should be >3μs.**
- **The modulation signal should be a pure TTL logic. Excessive interference (voltage fluctuation), voltage jump, and voltage spikes in the control signal will cause damage to the internal control circuit board and RF amplifier of the F8 laser.**



4.8 External Laser Path Protection

The laser exit aperture of F8 CO₂ laser is very sensitive. The particles and moisture attached to the lens can cause fatal damage to it. Well-sealed external optical path can prolong the service life of the laser and reduce the failure rate of the laser.

The problems that can happen to the front output window lens during the operation of the laser:

If the F8 CO₂ laser works in a dusty environment, or the environment is oily, colloidal particles, etc., the output window lens of the laser can be contaminated (dust, oil, water, etc.) very possibly. If the lens is contaminated, the coating on its surface can be burnt by high density laser power, which can cause its laser output power reduced and the spot mode deteriorated.

If the material processed comes with a plane (metal, etc.) with high reflectivity to 10.6 / 9.3μm wavelength, the laser exit window can be penetrated by the retro-reflected laser power due to the back reflection. If the working table of the laser processing system is an even metal plat (such as an aluminum plate), the front output window of the F8 CO₂ laser can be burnt out due to backward reflection.

To avoid the possible problems above, need to take the following measures:

If the equipment works in an environment full dust, oily particles, colloidal particles and other adherent pollutants, the front output window of the laser must be sealed.

The external optical path has to be well sealed, and blow N₂ to the optical path if necessary. If the whole optical path cannot be fully sealed, please install a protective lens at where is not less than 10cm away from the laser output window, and the protective lens must be anti-reflective on both sides.

If there is metal or other substance plane which has high reflectivity to the laser wavelength on the processing materials, please install retro-reflection isolator to avoid damage to the front output window of the laser caused by retro-reflection. If the working table of laser system is a flat metal plate, choose a honeycomb processing platform instead of a flat one to avoid back reflection.



4.9 Fixing

The laser can be mounted at any angle. If the laser is mounted with output window upside, must apply protection to the laser output window in case it is burnt out due to dust particles attached on it.

Avoid subjecting the laser cavity to strong external distortions in the mounting of F8 CO₂ laser. Long time last strong distortion can deform the cavity of the laser and cause the laser to detune, which can cause issues like the laser power decrease, the laser spot mode deterioration, and even the laser can't fire.

4.10 Cooling Alert

There is no flow ON/OFF inside the laser, it has the function of receiving and processing external flow ON/ OFF signals. Please follow the instructions below to connect the flow signal to the corresponding pin.

Chapter 5 Control & Operation

5.1 Operation Preparations

Apply the 48V DC power and the command signal through the DB15 connector on the laser to make the laser fire.

1. DC power supply (48V, output more than 1500W)
2. Fixing bracket (strong and flexible)
3. TTL logic generator (Modulation frequency: 0~100KHz, duty cycle: 0~100% adjustable)

5.2 Control terminal

The F8 CO₂ laser is controlled by an external modulation signal, the signal input to and output from the laser is a TTL logic. The ON/OFF and output power of the laser can be controlled by the ON/OFF and the duty cycle of the modulation signal. At the same time, there is also a rich detection and feedback signal interface on the laser to help the operator to tell the working state of the laser. The operator needs to prepare a differential linear drive module which is to provide the drive signal to the laser, TTL logic generator and other control and detection devices.

Note: The waveform shown below is a typical 0-5V TTL logic with adjustable duty cycle (or pulse width) and frequency:

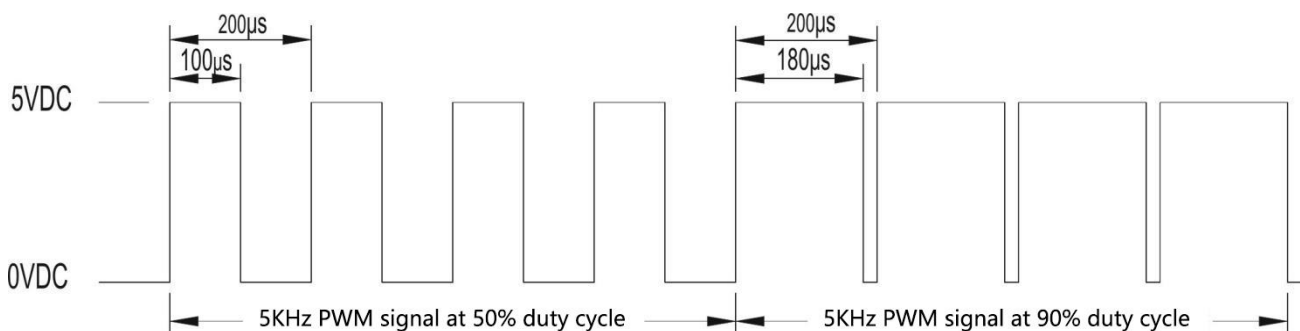



5.3 Control Signal Interface

There is a 15-pin DB15 female connector as the F8 laser as interface. Through this DB15 interface, the differential signal is input to control the laser output, and the state feedback signal of the laser can also be received from it to link the production line.

The DB15 connector:

DB15 Connector

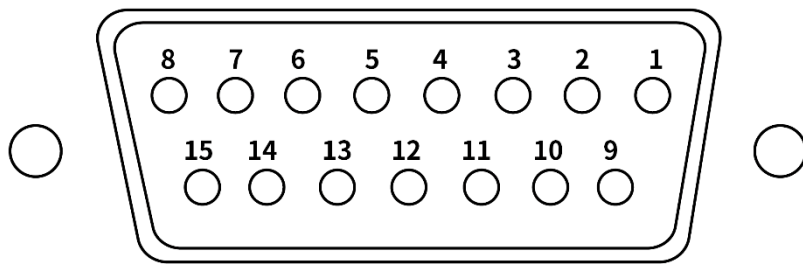

The pins of DB15 connector

PIN NO.	Function	Description
1	Open input	Logic high (5~24V Level), used with 13-pin COM
2	Enable laser	Enable the laser at high logic (5~24V level). Laser receives the PWM signal after 20s preparation time, and works with pin 13
3	Internal lockout	ON/OFF, internally connected to pin 13
4	Laser activation	ON/OFF, internally connected to pin 13
5	Fault detected	ON/OFF, internally connected to pin 13
6	Laser preparation	ON/OFF, internally connected to pin 13
7	Optical shutter open	ON/OFF, internally connected to pin 13
8	Output common	Output common ON/OFF, current limit 0.5A and self-recovery
9	PWM (+)	5V TTL logic, Logic high
10	PWM (-)	
11	5V power (+)	Output 500mA load capacity
12	5V power return	
13	Input common, as negative terminal	
14	/	
15	/	



Remark:

- 1) **Short-circuit pin 12 and 13 when not running with an external power supply.**
- 2) **The laser enable pin 2 can be used as a laser external interlock. If not, short-circuit pin 2 and 11.**
- 3) **PWM signal is connected to pin 9 and 10. pin 9 is signal positive, pin 10 is signal negative, and the TTL logic voltage is 5V.**

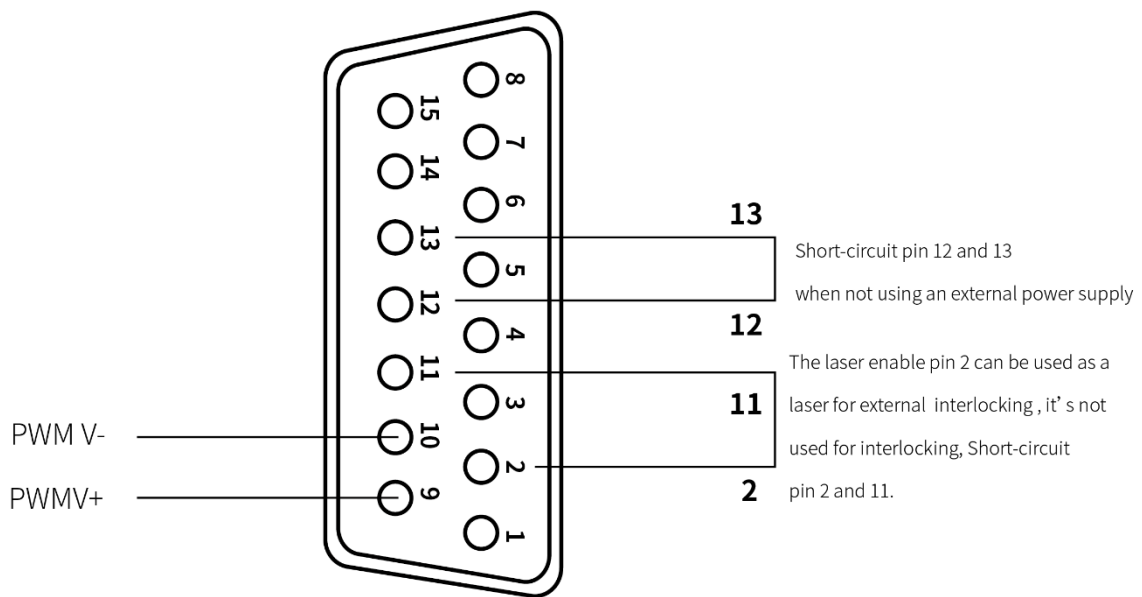

DB15 Simple wiring diagram

Input signal

The F8 CO₂ laser control signal is TTL logic, which is input through the DB15 connector, the corresponding pins are pin9 and pin10. Pin 9 is logic high and pin 10 is logic low. The level on pin9 is 3.3~5V and 0~0.3V on pin10.

Output signal

The F8 CO₂ laser output signal and alarm signal are displayed through the indicators on the panel. Two kinds of signal are output through the DB15, please see to the signal and corresponded pins in DB15 interface description. For the two kinds signal, please refer to the F8 CO₂ laser indicator description.



5.4 Control & Indicators

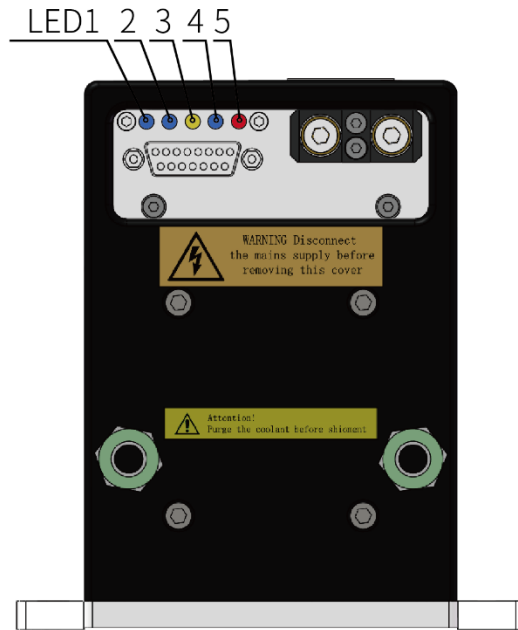

LED Indicators on panel

LED Indicators		
NO.	Color	Function
LED1	Blue	Always OFF
LED2	Blue	OFF: No fault Flashing 1time, OFF 1s: The power supply voltage is less than 46V. Flashing 2 times, OFF 1s: The power supply voltage is more than 50V. Flashing 3 times, OFF 1s: The temperature of the RF amplifier is more than 80°C Flashing 4 times, OFF 1s: The RF V+ feedback faulty Flashing 5 times, OFF 1s: The RF V- feedback faulty Flashing Quickly: Power Overload Alarm
LED3	Yellow	Always ON: The laser is ready. Flashing: The laser self-check or faulty, check with LED2.
LED4	Blue	Always ON: Connected to the external enable signal OFF: Not connected to the external enable signal
LED5	Red	Always ON: The laser is firing. OFF: The laser stops firing.



5.5 Start-up and pulse mode

Before operating the F8 CO₂ laser, please confirm the following items again:

1. The output voltage of DC power supply meets the working voltage required by F8 laser;
2. TTL control logic meets the laser operation requirements;
3. Power terminals and signal connectors are well connected;
4. The dust proof plug attached on the laser beam exit aperture is removed;
5. Protections to the laser and the personnel who are in the laser operation area are well done.

When the F8 CO₂ laser is properly powered with 48V DC, check if the fan or the chiller works OK, and then wait for 23s. Input PWM command signal and the laser fires immediately. The higher the PWM signal duty cycle, the stronger the laser output power.

The emitted laser is invisible, it can cause personnel injury, before power up, protections to the laser and the personnel who are in the laser operation area are well done.

F8 laser needs to be cooled with coolant, proper water temperature and flow are important to ensure the laser work fine. If the coolant temperature is more than 30°C, or the water flow is too less, the performance of the laser can be degraded or the laser can be damaged.

If the F8 CO₂ laser works in a high humidity environment, please check if there is condensation on the surface of the F8 CO₂ laser output window lens. Please turn off the laser and chiller if there is condensation. If the laser does not run for a long time, please cut the power to the laser and stop cooling. Keep the connectors of external optical path well sealed with rubber ring if the laser works in dusty environment.

5.6 Laser Operation Safety Tips

This product is class IV laser. It can cause personnel injury and fire due to its diffuse reflection, please always be careful!

Chapter 6 Technical Reference

6.1 Optical resonator

F8 is a RF-Excited CO₂ laser with waveguide optical resonator, which is excited with RF power supply as pump source, two metal slats are placed in parallel, about a few millimeters apart, the spacing varies from laser to laser. The V- is grounded through the metal shell, and the V+ is connected to the RF power supply through the RF feed-in device. There are two RF mirrors installed at both ends of metal slats to form a resonator for extraction laser.

The electrodes and optics are mounted inside a sealed off metal cavity, which is made of aluminum alloy. The gas mixture, V+, V- plates and cavity optics are sealed in a metal chamber. The RF power is introduced into the electrode plates through a special feed-through, and the laser gas mixture between the electrode plates is ionized to produce gain material, the laser output is extracted through cavity mirrors, and the laser beam from the window on the sealed cavity, window is sealed with ZnSe lens, which can efficiently extract laser energy and stabilize the vacuum seal. There are water channels inside V+ and V- electrode plate, both need to be cooling water. The water path of the V+ needs to be specially designed to ensure that the positive plate is insulated from the outside and smooth water flow.

F8 CO₂ laser principal diagram

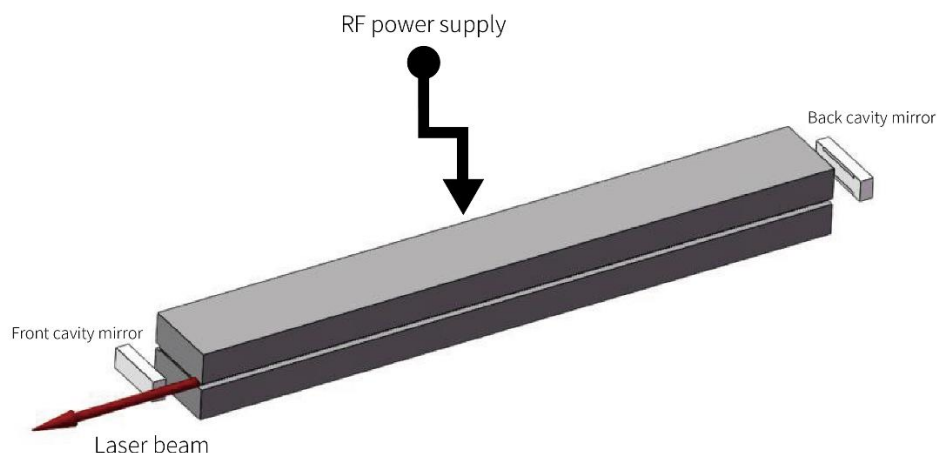

***The cooling water and V+ V- inductance coils are not shown in the figure.**



6.2 Cooling

Input RF power to ionize the CO₂ gas mixture to generate laser, meanwhile, around 80% of the RF power is converted into heat left in the discharge area. The heat spreads to the surface of the laser through its metal plates and is taken away by the running coolant in the plates to ensure the working stability of laser.

6.3 Polarization

The discharge area of the F8 CO₂ laser is parallel to the base, it is linearly polarized beam and vertical to the base. If circularly polarized beam is required, can apply a phase delay device in the optical path, like phase delay mirror.

6.4 Back-reflected beam isolation principle

It requires a retro-reflective beam isolator mounted in the external optical path if F8 CO₂ laser is applied to process high reflective materials. The principle is as follows: The laser beam is incident on a device that completely transmits P-polarized beam and completely reflects S-beam, such as a Brewster window, incident on a 45-degree phase delay device, like 45-degree phase retarder, incident on a focus lens to do laser process. After the beam P is reflected by the high reflective material, it passes through the phase delay mirror twice to become beam S. When it enters the Brewster window, it cannot be transmitted and totally reflected, and then cannot return to the F8 RF laser. The unidirectional optical path transmission device composed of Brewster window and 45-degree phase delay mirror is a kind of beam isolator.

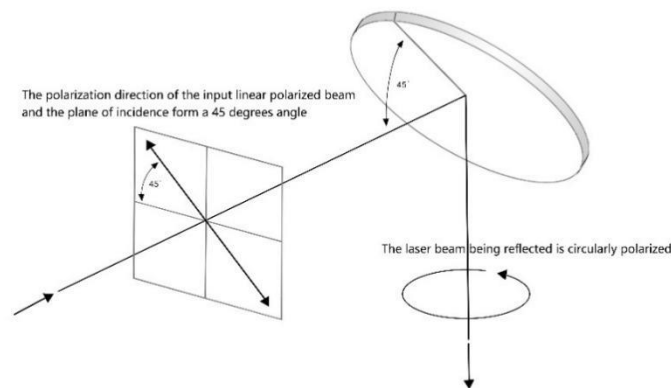

45° Phase delay mirror principle diagram



6.5 External optical path & attentions

Generally, in the laser process, the laser beam is expanded and then focused before it reaches the processing materials. On the laser cutting machines, the laser beam is reflected by 3pcs of full reflectors which are mounted in 45 degrees on the machine and then focused by laser lens to reach the material. On laser marking machines, the laser beam passes the beam expander firstly, and then reflected by the X Y mirrors in the galvo, finally reaches to the material after being focused by the F-theta lens to achieve high precision process in small field.

Good exhausting is required in the process area to protect the lens from harm of smoke from processing. The external optical path from beam exit aperture to focusing optic on machines shall be well sealed, blow clean air or nitrogen to the optical path if necessary. Pay attention to each component in the optical path during mounting and tuning, there shall be no contaminant on any of them and do not apply too much mechanical stress to it.

6.6 RF Power supply

The F8 CO₂ laser is driven by 81.36MHz RF power supply which is powered by a 48V DC power supply, and the laser output power is decided by the external PWM signal given to RF power supply. 81.36MHz RF signal generated from a crystal oscillator, and it finally outputs as high power RF output through the amplification circuit.

The status of LED indicators on RF power supply can help to tell the laser state, such as its work condition, temperature, cooling flow, voltage, etc. It helps operators to learn the laser conditions from the indicators.



6.7 Cooling & coolant temperature setting

Proper cooling is essential for the F8 CO₂ laser. Most of the RF power is converted into heat which has to be taken away by matched cooling system to keep the laser cool. According to the difference ambient temperature and humidity, the cooling water temperature is 20~30°C, and the flow is not less than 5L/min.

Please refer to the ambient temperature and humidity when setting the coolant temperature to prevent condensation on the laser. Condensation on laser can cause irreversible damage to the laser and affect the service life. The coolant temperature should be higher than the dew point of the air.

While the cooling temperature is higher than 30°C, the waste heat generated in the discharge area cannot be effectively exported, which will cause the laser power drop and increase the risk of RF power supply failures.

The cooling water shall be deionized pure water. Tap water it will cause scaling and corrosion of the waterway, causing fatal damage to the laser.

Do not run the laser in freezing temperature. There may be ice crystals in coolant which can damage the cooling path in F8 and affect its lifetime. In the storage of F8, the coolant in its cooling path has to be drained, in case it corrodes the cooling path, or breaks it in freezing environment to cause damage to the laser.

6.8 Modulation signal & PWM method

The laser output power is decided by the external PWM signal. The laser generates corresponding laser pulse output according to the pulse width and frequency of the command signal which controls ON/ OFF of RF power supply. The maximum duty cycle of F8 is 100%.

$$W = \frac{\text{Duty Cycle} * 1000}{Q}$$

Formula description:

W	Modulation pulse width, in μs
Q	Modulation frequency, in KHz

E.g., with 5KHz frequency and 60% duty cycle, according to the formula above, $W = 60\% * 1000 / 5 = 120\mu\text{s}$.

6.9 Marking & engraving

Input PWM signal to modulate the laser pulse width and laser pulse frequency for modulating the laser output power. In some materials processing, better processing results can be achieved with certain laser frequency and pulse.

95% is recommended as the maximum duty cycle value, because the laser output power is hardly increased between 95% and 100% PWM duty cycle (as shown in the figure below).

When the laser is close to its power saturation, the PWM duty cycle produces a non-linear power function, which flattens out when the duty cycle is about 95%. If keep running at 100% duty cycle, it increases the power consumption and 5% thermal load.

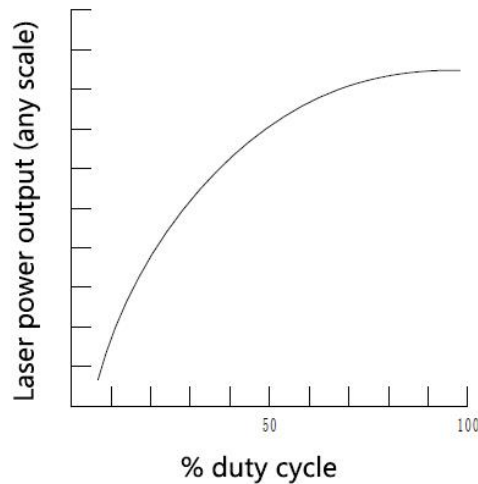

Chapter 7 Maintenance

If damage on optics of the laser found, please contact SPT LASER for after-sale service.

The F8 CO₂ laser comes with a sealed maintenance free design, only regular inspection and cleaning of optics are required. Dust and cotton fiber are the common contaminants on optics of the laser which can cause laser beam absorption and scattering, which can cause permanent damage to optics in extreme cases. And permanent damage to the laser is also possible if the optics are removed improperly.

Regular maintenance

Please turn off the device and cut the power, stop the chiller and check whether the cooling water is clean without impurities and pollution, and replace the cooling water regularly; check if the coolant temperature matches the ambient temperature, and whether there is condensation on the laser chamber, and reset the coolant temperature if necessary. Check if there is dust on the laser chamber, clean the dust with a wet cloth, ensure no water enters the laser which can cause damage to it.

Maintenance of Laser optics and external optics

Please turn off the equipment and cut the power, stop the chiller, and seal the external optical path of the laser processing equipment. Remove the lens with gloves, put it on the non-woven fabric or special lens cleaning cloth. Use cleaning cloth dipped Alcohol or acetone to clean the lens and can only move in one direction. Do not reuse the used lens cleaning cloth. If the laser is used in a dusty environment, please blow it with filtered clean air or high-purity nitrogen firstly.

Maintenance materials requirements:

Materials	Requirements
Gloves	No dust
Nitrogen	>99.9%
Alcohol	Spectral Grade
Acetone	Spectral Grade

Chapter 8 Q&A

1. Q: Why does the laser take some time to fire after getting command signal when it's powered on?

A: To extend the service life of F8 CO2 laser, the internal chip is set with a 23s delay. To preheat the laser gas mixture in the optical resonator during the delay to prevent the RF power supply from being overloaded instantly.

2. 2.Q: Is external pre-ionization signal required to be given to the laser before it fires?

A: No, F8 CO2 laser does not require any pre-ionization signal from external control system.

3. 3.Q: What matters during the storage and shipping of the laser?

A: The laser beam exit aperture has to be sealed to prevent any possible contamination to the lens. Handle it gently to protect the laser from any accidental impact.

4. Q: What are the requirements for the operation environment of the laser?

A: The ambient temperature should be maintained at 5°C ~40 °C. External dust protection is necessary if the laser runs in dusty fields where the laser exit window is easy to be burnt. The humidity has to be within recommended range to ensure no condensation on the laser. The environmental pH value is neutral.

5. 5.Q: How to clean output window of the laser if it is contaminated? Can do it with a cotton swab?

A: The laser beam exit lens can be wiped. Wipe it gently with special lens cleaning paper dipped in alcohol after blowing away the bigger contaminants on it. If the lens surface is seriously contaminated and damaged, do not run the laser, avoid completely lens burnt, end in more damage.

6. Q: If the size of the laser spot is known, how to decide the size of the optics in the external optical path?

A: The size of the optics in the external laser path shall be 1.5 to 2 times of the actual spot size.



7. Q: Power at the laser exit is strong, but it is very low on processing materials, what would be the reasons?

A: Generally, there is high laser power loss in the external optical path, the following points shall be checked:

1. Check if the size and the aperture of optics in the external optical path are big enough;
2. Check if the optics in external optical path quality is reliable (the wastage of single optic shall be no more than 3%);
3. Check if there is contamination or damage on the optics in the external optical path;
4. Check if the alignment of external optical path is properly done.

8. Q: What to do when the laser power output is low or unstable during operation?

A:1. Test if the voltage of DC power supply connected to the laser is normal or not with a multimeter;

2. Test if the command signal to the laser is normal or not with an oscilloscope.

9. Q: There are many sealing labels attached on the laser, what are they for?

A: If the sealing label is damaged, the warranty of the laser fails.